

## Thermally-Enhanced High Power RF LDMOS FET 240 W, 28 V, 1930 – 1995 MHz

### Description

The PXAC192908FV is a 240-watt LDMOS FET with an asymmetrical design intended for use in multi-standard cellular power amplifier applications in the 1930 to 1995 MHz frequency band. Features include dual-path design, high gain and thermally-enhanced package with earless flanges. Manufactured with Infineon's advanced LDMOS process, this device provides excellent thermal performance and superior reliability.

PXAC192908FV  
Package H-37275G-6/2

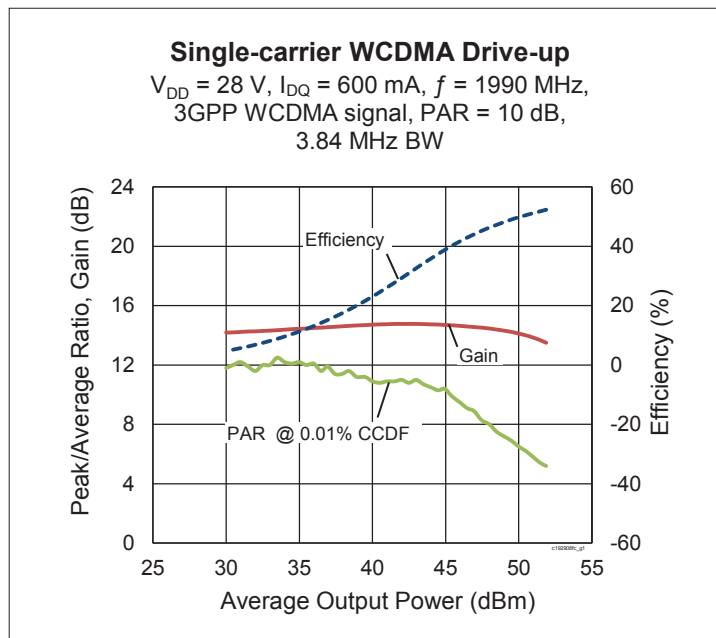
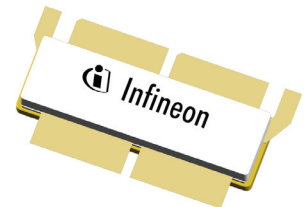

### Features

- Broadband internal input and output matching
- Asymmetric Doherty design
  - Main:  $P_{1dB} = 120\text{ W Typ}$
  - Peak:  $P_{1dB} = 220\text{ W Typ}$
- Typical Pulsed CW performance, 1990 MHz, 28 V, combined outputs
  - Output power at  $P_{1dB} = 240\text{ W}$
  - Efficiency = 54%
  - Gain = 14 dB
- Capable of handling 10:1 VSWR @ 28 V, 240 W (CW) output power
- Integrated ESD protection
- Human Body Model, Class 2 (per ANSI/ESDA/ JEDEC JS-001)
- Low thermal resistance
- Pb-free and RoHS compliant

### RF Characteristics

#### Single-carrier WCDMA Specifications (tested in Infineon Doherty test fixture)

$V_{DD} = 28\text{ V}$ ,  $I_{DQ} = 0.6\text{ A}$ ,  $V_{GS(PEAK)} = 0.55\text{ V}$ ,  $P_{OUT} = 70\text{ W avg}$ ,  $f_1 = 1990\text{ MHz}$ , 3GPP signal, channel bandwidth = 3.84 MHz, peak/average = 10 dB @ 0.01% CCDF

Characteristic	Symbol	Min	Typ	Max	Unit
Gain	$G_{ps}$	13	14	—	dB
Drain Efficiency	$\eta_D$	45	49	—	%
Adjacent Channel Power Ratio	ACPR	—	-28	-25	dBc

All published data at  $T_{CASE} = 25^\circ\text{C}$  unless otherwise indicated

**ESD:** Electrostatic discharge sensitive device—observe handling precautions!

**DC Characteristics** (each side)

Characteristic	Conditions	Symbol	Min	Typ	Max	Unit
Drain-Source Breakdown Voltage	$V_{GS} = 0\text{ V}$ , $I_{DS} = 10\text{ mA}$	$V_{(BR)DSS}$	65	—	—	V
Drain Leakage Current	$V_{DS} = 28\text{ V}$ , $V_{GS} = 0\text{ V}$	$I_{DSS}$	—	—	1	$\mu\text{A}$
	$V_{DS} = 63\text{ V}$ , $V_{GS} = 0\text{ V}$	$I_{DSS}$	—	—	10	$\mu\text{A}$
On-State Resistance (main)	$V_{GS} = 10\text{ V}$ , $V_{DS} = 0.1\text{ V}$	$R_{DS(on)}$	—	0.11	—	$\Omega$
	(peak) $V_{GS} = 10\text{ V}$ , $V_{DS} = 0.1\text{ V}$	$R_{DS(on)}$	—	0.06	—	$\Omega$
Operating Gate Voltage (main)	$V_{DS} = 28\text{ V}$ , $I_{DQ} = 0.6\text{ A}$	$V_{GS}$	2.5	2.65	2.75	V
	(peak) $V_{DS} = 28\text{ V}$ , $I_{DQ} = 0\text{ A}$	$V_{GS}$	0.45	0.55	0.75	V
Gate Leakage Current	$V_{GS} = 10\text{ V}$ , $V_{DS} = 0\text{ V}$	$I_{GSS}$	—	—	1	$\mu\text{A}$

**Maximum Ratings**

Parameter	Symbol	Value	Unit
Drain-Source Voltage	$V_{DSS}$	65	V
Gate-Source Voltage	$V_{GS}$	-6 to +10	V
Operating Voltage	$V_{DD}$	0 to +32	V
Junction Temperature	$T_J$	225	$^{\circ}\text{C}$
Storage Temperature Range	$T_{STG}$	-65 to +150	$^{\circ}\text{C}$
Thermal Resistance (Doherty, $T_{CASE} = 70^{\circ}\text{C}$ , 200 W CW, 1960 MHz, 28V, $I_{DQ}(\text{main}) = 600\text{ mA}$ , $V_{GS}(\text{peak}) = 0.55\text{ V}$ )	$R_{\theta JC}$	0.32	$^{\circ}\text{C/W}$

**Ordering Information**

Type and Version	Order Code	Package Description	Shipping
PXAC192908FV V1 R0	PXAC192908FVV1R0XTMA1	H-37275G-6/2, earless flange	Tape & Reel, 50 pcs
PXAC192908FV V1 R250	PXAC192908FVV1R250XTMA1	H-37275G-6/2, earless flange	Tape & Reel, 250 pcs

**Typical Performance** (data taken in a production Doherty test fixture)

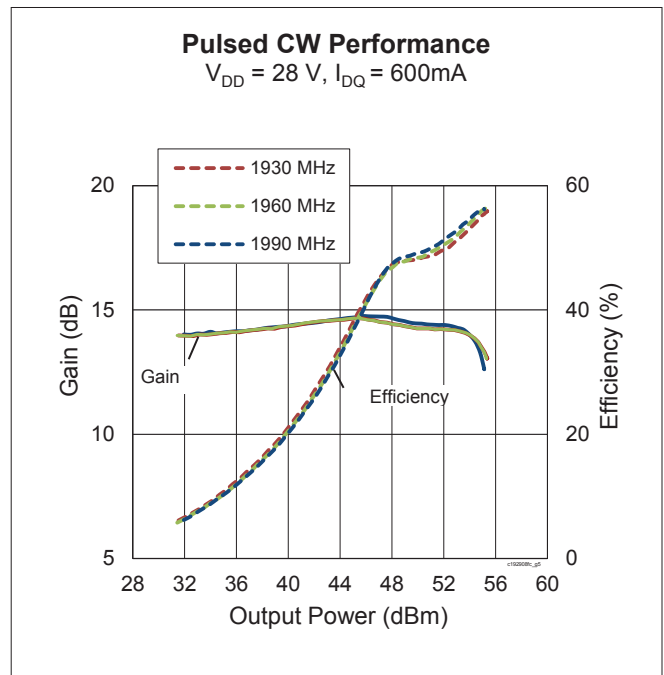
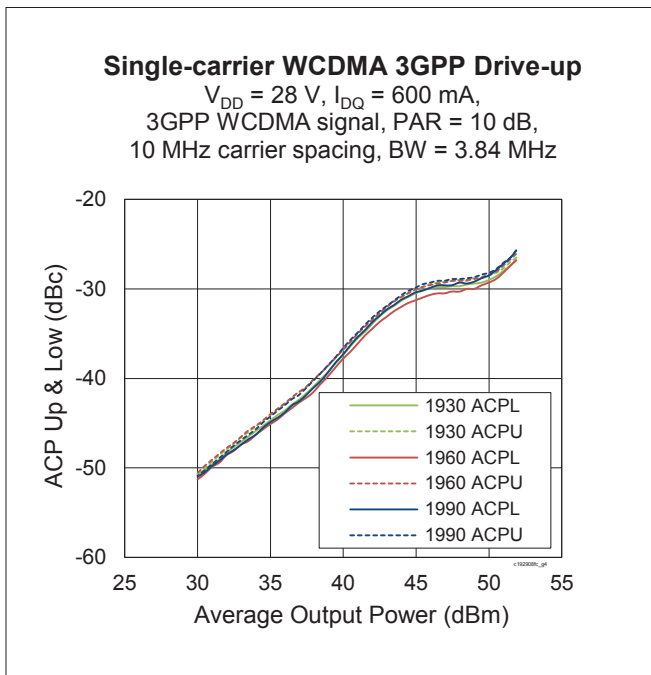
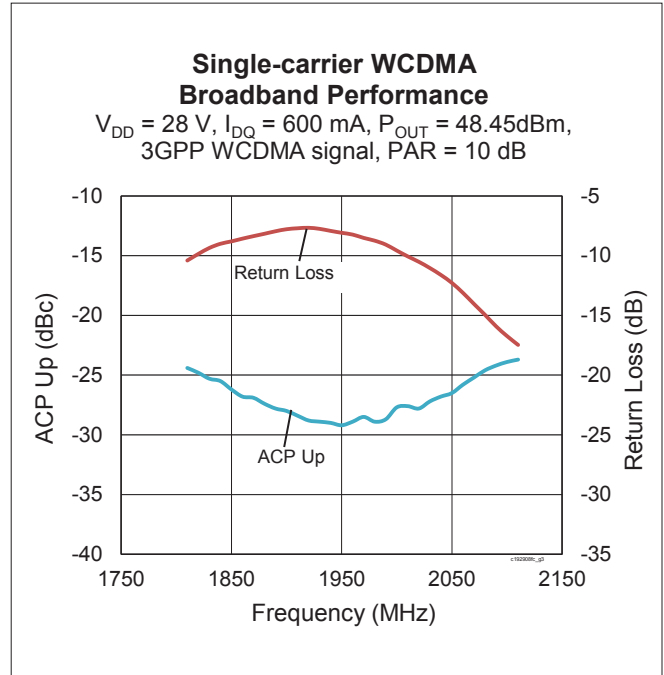
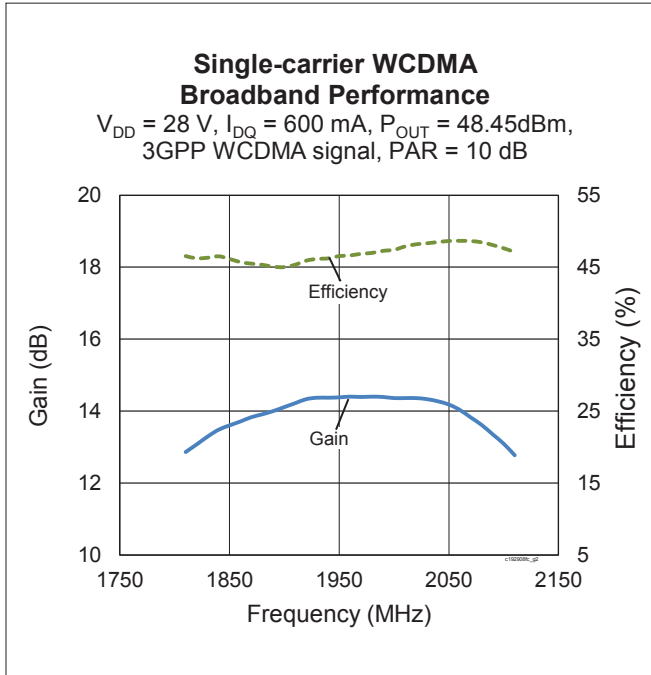

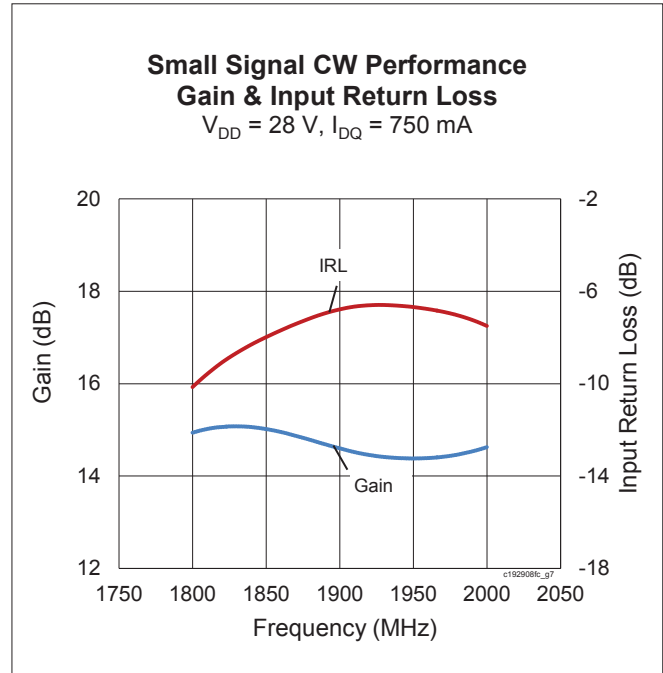
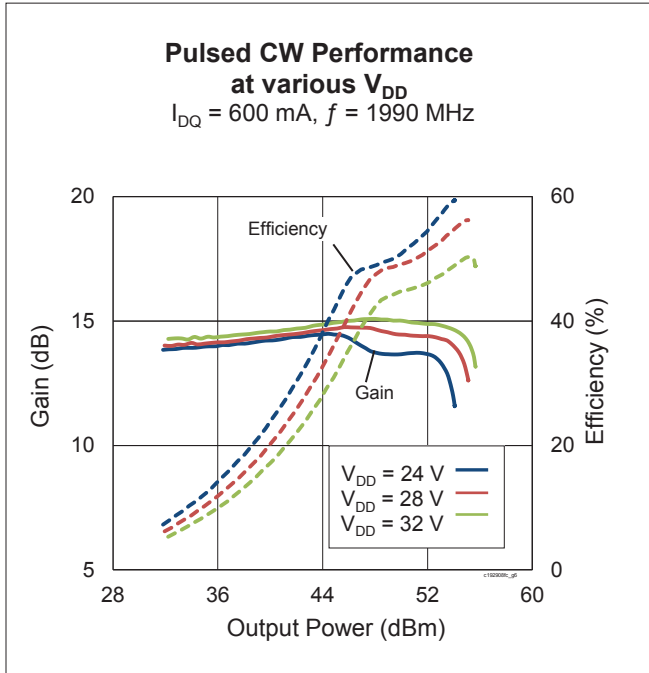
**Typical Performance (cont.)**

**Load Pull Performance**
**Main Side Load Pull Performance** – Pulsed CW signal: 16  $\mu\text{s}$ , 10% duty cycle,  $V_{DD} = 28 \text{ V}$ ,  $I_{DQ} = 600 \text{ mA}$ 

Freq [MHz]	$Z_s$ [ $\Omega$ ]	P1dB									
		Max Output Power					Max PAE				
		$Z_I$ [ $\Omega$ ]	Gain [dB]	$P_{OUT}$ [dBm]	$P_{OUT}$ [W]	PAE [%]	$Z_I$ [ $\Omega$ ]	Gain [dB]	$P_{OUT}$ [dBm]	$P_{OUT}$ [W]	PAE [%]
1930	8.0 – j11.0	2.1 – j4.7	18.0	51.10	128.8	50.4	3.6 – j2.7	20.2	50.12	102.8	62.5
1960	11.9 – j11.9	2.1 – j4.7	18.2	51.10	128.8	51.0	3.6 – j2.9	20.2	50.08	101.9	61.6
1990	18.0 – j10.4	2.1 – j4.8	18.3	50.91	123.3	49.7	3.63 – j2.6	20.5	49.78	95.1	61.3

**Peak Side Load Pull Performance** – Pulsed CW signal: 16  $\mu\text{s}$ , 10% duty cycle,  $V_{DD} = 28 \text{ V}$ ,  $I_{DQ} = 90 \text{ mA}$ 

Freq [MHz]	$Z_s$ [ $\Omega$ ]	P1dB									
		Max Output Power					Max PAE				
		$Z_I$ [ $\Omega$ ]	Gain [dB]	$P_{OUT}$ [dBm]	$P_{OUT}$ [W]	PAE [%]	$Z_I$ [ $\Omega$ ]	Gain [dB]	$P_{OUT}$ [dBm]	$P_{OUT}$ [W]	PAE [%]
1930	1.7 – j5.3	5.3 – j3.8	18.0	54.24	265.5	55.6	2.9 – j2.0	19.6	53.04	201.4	66.3
1960	2.0 – j5.8	5.3 – j3.7	18.4	54.16	260.6	55.7	2.9 – j2.2	20.1	52.90	195.0	66.0
1990	3.2 – j6.9	6.3 – j2.8	18.7	54.08	255.9	54.7	2.9 – j2.2	20.3	52.88	194.1	65.0

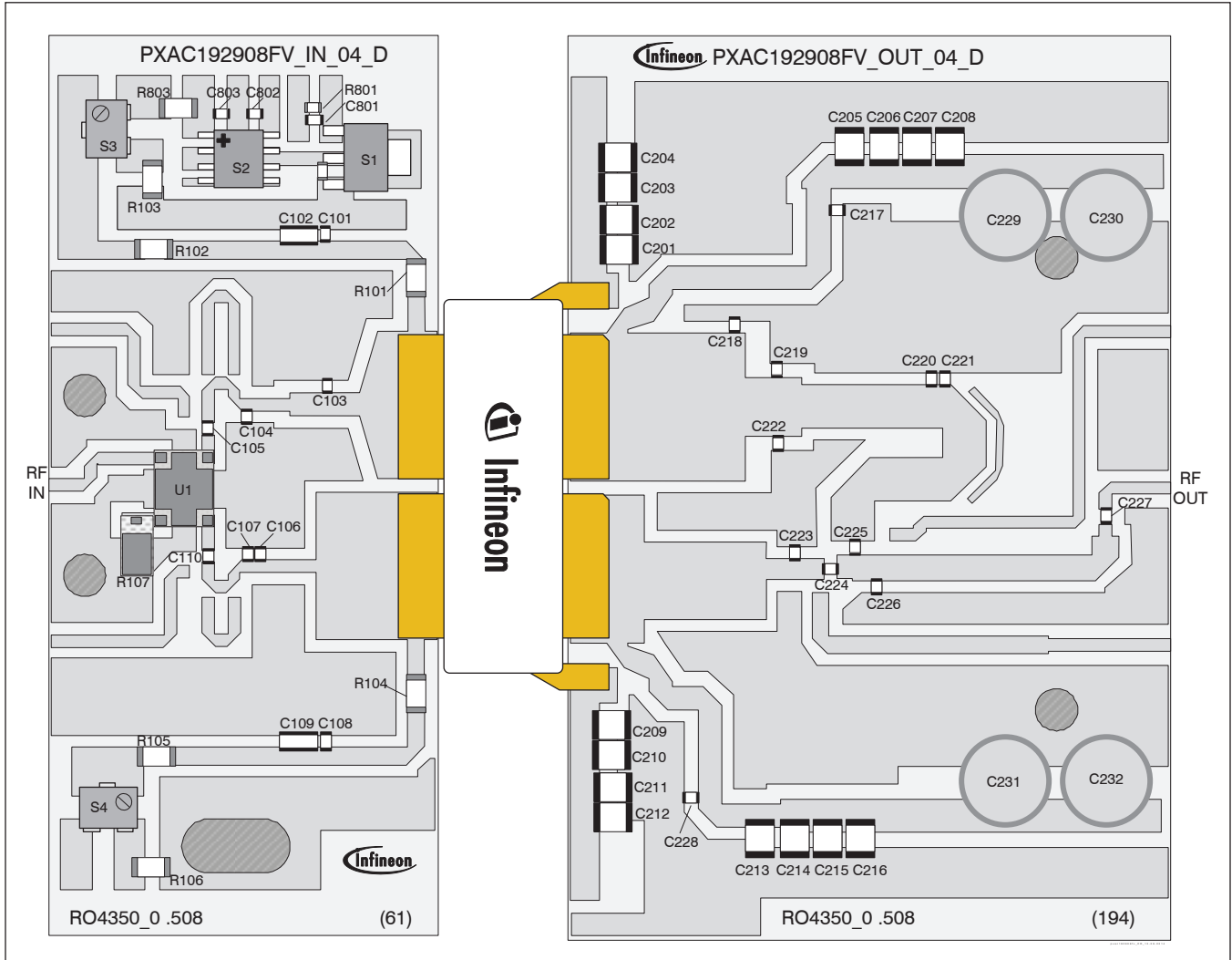
Reference Circuit , 1930 – 1990 MHz



Reference circuit assembly diagram (not to scale)

**Reference Circuit** (cont.)

**Reference Circuit Assembly**

DUT	PXAC192908FV V1
Test Fixture Part No.	LTA/PXAC192908FV V1
PCB	Rogers 4350, 0.508 mm [0.020"] thick, 2 oz. copper, $\epsilon_r = 3.66$ , $f = 1930 - 1990$ MHz
Find Gerber files for this test fixture on the Infineon Web site at <a href="http://www.infineon.com/rfpower">http://www.infineon.com/rfpower</a>	

**Components Information**

Component	Description	Suggested Manufacturer	P/N
<b>Input</b>			
C101, C108, C105	Capacitor, 18 pF	ATC	ATC600F180JT250X
C102, C109	Capacitor, 10 $\mu$ F	Murata	LLL31BC70G106MA01L
C103	Capacitor, 1 pF	ATC	ATC600F1R0CT250X
C104	Capacitor, 1.2 pF	ATC	ATC600A1R2CT250X
C106	Capacitor, 0.5 pF	ATC	ATC600F0R5CT250X
C107	Capacitor, 1.1 pF	ATC	ATC600F1R1CT250X
C801, C802, C803	Capacitor, 1000 pF	Panasonic Electronic Components	ECJ-1VB1H102K
R101, R104	Resistor, 5600 $\Omega$	Panasonic Electronic Components	ERJ-8RQJ5R6V
R102, R105	Resistor, 1000 $\Omega$	Panasonic Electronic Components	ERJ-8GEYJ102V
R103, R106	Resistor, 5.1 $\Omega$	Panasonic Electronic Components	ERJ-8GEYJ5R1V
R107	Resistor, 50 $\Omega$	Richardson	C16A50Z4
R801	Resistor, 1300 $\Omega$	Panasonic Electronic Components	ERJ-3GEYJ132V
R802	Resistor, 1200 $\Omega$	Panasonic Electronic Components	ERJ-3GEYJ122V
R803	Resistor, 5100 $\Omega$	Panasonic Electronic Components	ERJ-8GEYJ512V
S1	Voltage Regulator	Texas Instruments	LM78L05ACM
S2	Transistor	Infineon Technologies	BCP56
S3, S4	Potentiometer, 2k $\Omega$	Bourns Inc.	3224W-1-202E
U1	Hybrid coupler	Anaren	X3C19P1-04S
<b>Output</b>			
C201, C202, C203, C204, C205, C206, C207, C208, C209, C210, C211, C212, C213, C214, C215, C216	Capacitor, 10 $\mu$ F	Taiyo Yuden	UMK325C7106MM-T
C217, C224, C225, C227, C228	Capacitor, 18 pF	ATC	ATC600F180JT250X
C218	Capacitor, 0.5 pF	ATC	ATC600F0R5CT250X
C219	Capacitor, 1.8 pF	ATC	ATC600F1R8CT250X
C220	Capacitor, 0.8 pF	ATC	ATC600F0R8CT250X
C221	Capacitor, 0.4 pF	ATC	ATC600F0R4CT250X
C222, C226	Capacitor, 0.2 pF	ATC	ATC600F0R2CT250X
C223	Capacitor, 1.0 pF	ATC	ATC600F1R0CT250X
C229, C230, C231, 232	Capacitor, 220 $\mu$ F	Panasonic Electronic Components	EEE-FP1V221AP

**Pinout Diagram** (top view)

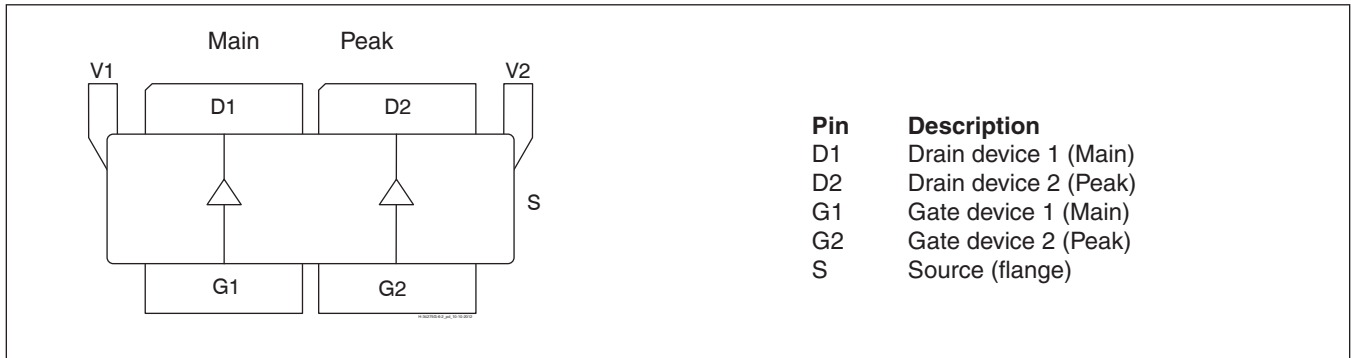

Lead connections for PXAC192908FV

Package Outline Specifications

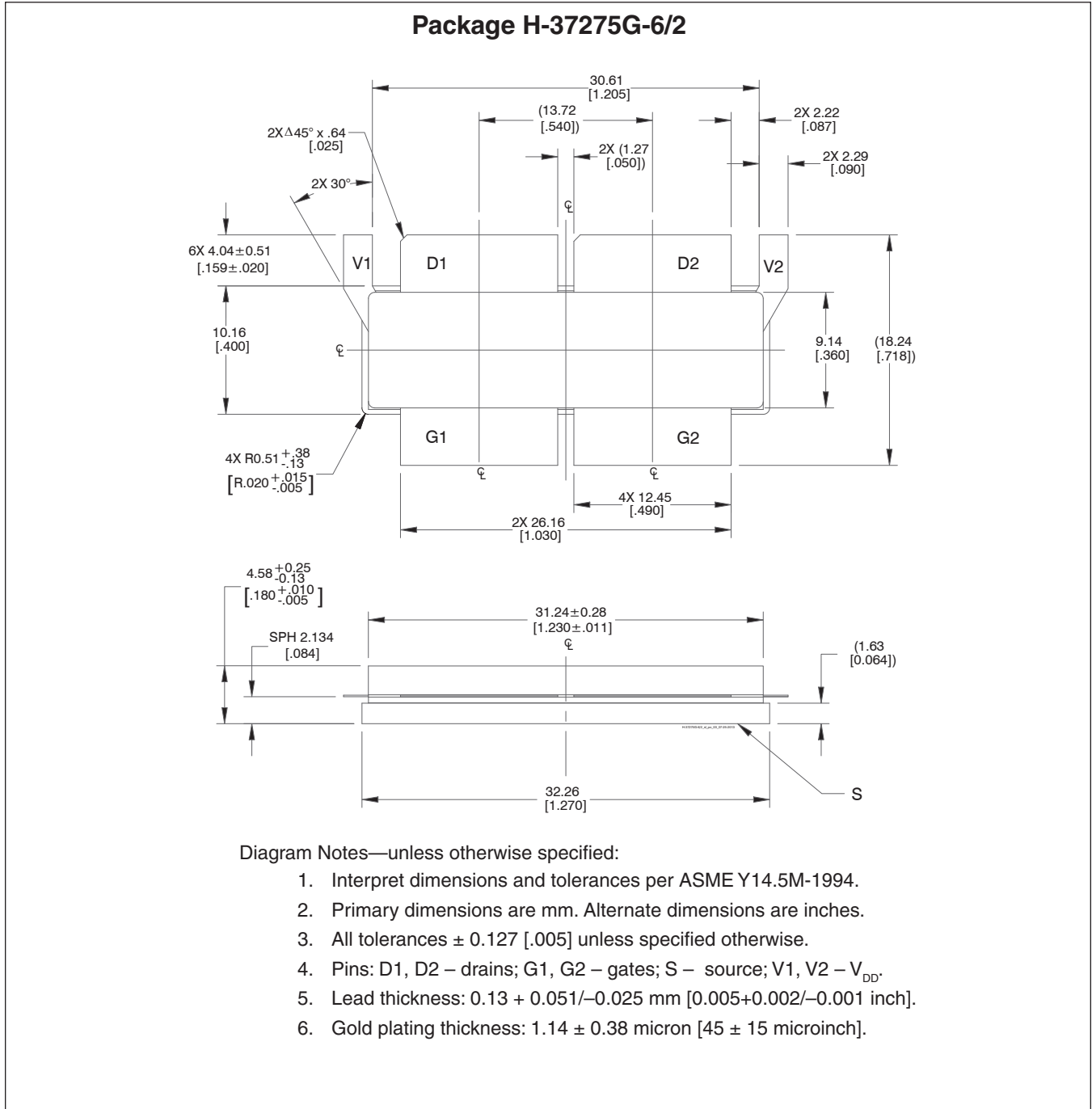

Find the latest and most complete information about products and packaging at the Infineon Internet page <http://www.infineon.com/rfpower>